

LANCER[®]

2010 PRICING CATALOG

Effective January 1, 2010



Don't miss the **NEW PRODUCTS** page!

BEVERAGE DISPENSERS & ACCESSORIES

LANCER PARTS AND EQUIPMENT LIMITED WARRANTY

LANCER® warrants new replacement parts, equipment, and hermetically sealed refrigeration systems (HSRS) to be free from defects in material and workmanship under normal use and service. The duration of the warranty for these different items is shown below. **LANCER**®'s obligation, hereunder, shall be limited to repairing or replacing any part, or part of said equipment or system which our examination discloses to be defective and which has not been subjected to any accident, negligence, alteration, abuse or misuse, and additionally in the case of refrigeration and/or electrical systems, not subjected to high, low or fluctuating electrical voltage. **LANCER**®'s obligation does not provide for service calls from factory representatives or from any other agency and shall not include reimbursement for labor charges incident to removal of any parts or the reinstallation of the same. **LANCER**® will accept parts, equipment, and refrigeration systems freight prepaid by sender. **LANCER**® will assume freight charges within the continental United States, or to a port of export within the continental United States for international shipments. **LANCER**® will not be responsible for international freight, customs fees or duties at country of destination. In the event **LANCER**® establishes sales and service organizations outside the continental limits of the United States, the point of shipment of repaired or replaced parts or equipment may, at **LANCER**® option, be made from that location, with freight charges assumed to the point of export from the country in which a sales and service organization is established.

Warranty Periods

Parts:

Ninety (90) days from date of original shipment from a **LANCER**® facility or from an authorized Lancer Distributor.

Equipment:

One (1) year from date of original shipment from a **LANCER**® facility or from an authorized Lancer Distributor.

Hermetically Sealed Refrigeration System:

For the following components of the HSRS, i.e., the compressor, condenser, evaporator, coldpack, capillary tubes, and drier, five (5) years from date of original shipment from a **LANCER**® facility or from an authorized Lancer Distributor.

All other parts of the HSRS, one (1) year from date of original shipment from a **LANCER**® facility or from an authorized Lancer Distributor.

EXCEPT AS SPECIFICALLY SET FORTH HEREIN, **LANCER**® MAKES NO EXPRESS WARRANTIES AS TO ANY MATTER WHATSOEVER AND HEREBY DISCLAIMS ALL IMPLIED WARRANTIES INCLUDING, WITHOUT LIMITATION, THE IMPLIED WARRANTIES OF MERCHANTABILITY AND FITNESS FOR ANY PARTICULAR PURPOSE. IN NO EVENT SHALL **LANCER**® BE LIABLE OR OBLIGATED TO CUSTOMER OR TO ANY THIRD PARTY FOR INCIDENTAL, CONSEQUENTIAL, OR SPECIAL DAMAGES, REGARDLESS OF THE THEORY OF LIABILITY, ARISING OUT OF, OR IN ANY MANNER RELATED TO **LANCER**® PARTS, EQUIPMENT, OR HSRS, OR ANY DELAY WITH RESPECT TO ITS DELIVERY.



REV: 01/16/01
P.N.: 38-0508/03

CONTENTS

NEW PRODUCTS	1
Bevariety ACIB—22"	
Bevariety ACIB—30"	
Bevariety ACIB—44"	
Bevariety Drop In—2323	
Flavor Craze Tower—6-Flavor Bevariety™ Station (MVU)	
Flavor Craze Tower—Flavor Shot	
Flavor Select Series	2
FS22	
FS30	
FS44	
FS60	
Ice Beverage Dispensers	3
4500—22"	
4500—25"	
4500—30"	
4500—44"	
Ice Dispensers	3
4400—22"	
4400—30"	
Ice Cooled Drop-In Dispensers	4-6
2200—1523	
2300—2323	
23308—3023	
Ice Chest	6
Ice Chest	
Counter Electric Dispensers	7-8
Ambient Carbonated	
500	
1500	
2500	
Cold Carbonated	
9000	
8000	
Towers	9
300	
Pre-Mix Dispensers	10
1500 CED	
Accessories	11-12
Carbonators	
Installation Kits	
Regulators	
Bundle Tubing	
Syrup Pumps	
BIB Racks	
Fittings	13
Directory of Offices and Authorized Distributors	14-20

Corporate Office

6655 Lancer Boulevard
 San Antonio, Texas 78219
 210-310-7000
 Fax 210-310-7250
 www.lancercorp.com

Georgia Office

645 Hembree Parkway, Suite J
 Roswell, GA 30076
 770-343-8828
 Fax 770-475-8646

Prices effective 1/1/10 and are subject to change without notice.



NEW PRODUCTS

BEVARIETY™

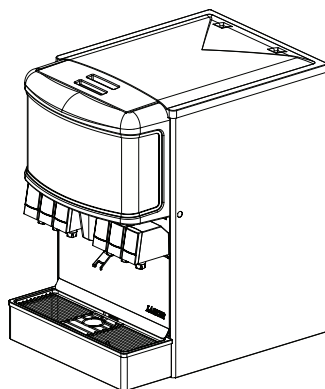

ACIB 22"

W: 22" D: 31" H: 35 1/2"
 Weights:
 Operating: 420 lbs
 Counter (w/o ice): 270 lbs
 Shipping: 292 lbs
 Ice capacity: 150 lbs

PART NUMBER	DESCRIPTION	LIST PRICE
ACIB 22"		
85-20408-0-2-31S	8-Flavor includes 4-Flavor Bevariety™ Station (MVU)	\$8,548.00
85-20406-0-0-31S	Straight 6-LEV®	\$7,468.00
ACIB 30"		
85-21808-0-0-31S	Straight 8-LEV®	\$9,027.00
85-21810-0-2-31S	12-Flavor includes 6-Flavor Bevariety™ Station (MVU)	\$9,148.00
ACIB 44"		
85-20808-0-2-31S	Includes two - 22" 8-Flavor Bevariety™ Stations (MVUs)	\$8,768.00
DROP IN 2323		
85-2306C-111	Straight 6-LEV®	<i>Call For Pricing</i>
85-2308C-122	Straight 8-LEV®	\$7,602.00
85-2308C-122V	12-Flavor includes 6-Flavor Bevariety™ Station (MVU)	\$8,928.00

FLAVOR CRAZE TOWER

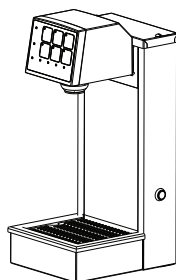

Flavor Craze Tower with 6-Flavor Bevariety™ Station (MVU)

W: 7 1/2" D: 9 1/4" H: 16 1/2"
 Weights:
 Shipping: 15 lbs

PART NUMBER	DESCRIPTION	LIST PRICE
85-3136-MVU	Free Standing Tower with 6-Flavor Bevariety™ Station (MVU)	\$2,289.00
85-3136-MVUFC	Flavor Shot Tower	\$1,760.00

Flavor Select Series

	PART NUMBER	VALVE TYPE	NUMBER OF BRANDS	NUMBER OF BONUSES	LIST PRICE
FS SERIES					
22" Wide Cube Ice					
FS22-8	85-14408-06-2	LFCV	8	6	\$9,498.00
22" Wide Cubelet Ice					
FS22N-8	85-14408N-06-2	LFCV	8	6	\$9,365.00
30" Wide Cube Ice					
FS30-16	85-14816-12	LFCV	16	12	\$12,952.00
FS30-14	85-14814-12	LFCV	14	12	\$12,580.00
FS30-12	85-14812-12	LFCV	12	12	\$12,207.00
FS30-10	85-14810-12	LFCV	10	12	\$11,835.00
30" Wide Cubelet Ice					
FS30N-16	85-14816N-12	LFCV	16	12	\$13,369.00
FS30N-14	85-14814N-12	LFCV	14	12	\$12,998.00
FS30N-12	85-14812N-12	LFCV	12	12	\$12,626.00
FS30N-10	85-14810N-12	LFCV	10	12	\$12,253.00
44" Wide {2-22" Units with a common wrap}					
FS44-16CN	85-15816-081209	LFCV	16	12	\$17,900.00
FS44-16CC	85-15816-081208	LFCV	16	12	\$17,537.00
FS44-16NN	85-15816-081210	LFCV	16	12	\$18,262.00
60" Wide {2-30" Units with a common wrap}					
FS60-32CN	85-15832-090908	LFCV	32	12	\$28,710.00
FS60-32CC	85-15832-090907	LFCV	32	12	\$28,093.00
FS60-32NN	85-15832-090909	LFCV	32	12	\$29,328.00
Accessories Needed					
FS Install Kit	82-3622				\$336.62

FS Series

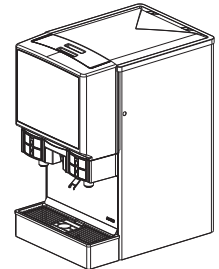

FS22

W: 22" D: 30 1/2" H: 40 1/4"
 Weights:
 Operating: 480 lbs
 Counter (w/o ice): 280 lbs
 Shipping: 310 lbs
 Ice capacity: 200 lbs

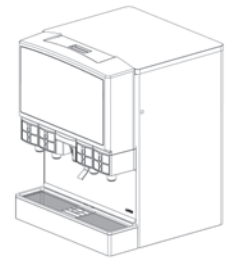

FS30

W: 30" D: 30 1/2" H: 40 1/4"
 Weights:
 Operating: 620 lbs
 Counter (w/o ice): 320 lbs
 Shipping: 356 lbs
 Ice capacity: 290 lbs

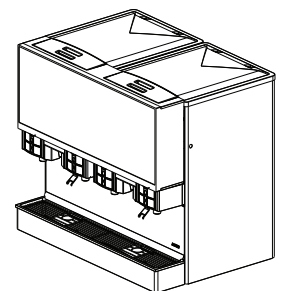

FS44

W: 44 3/4" D: 30 1/2" H: 40 1/4"
 Weights:
 Operating: 1020 lbs
 Counter (w/o ice): 620 lbs
 Shipping: (2) 310 lbs + Kit
 Ice capacity: 400 lbs (200 lbs each)

Ice Beverage Dispensers

4500 IBD — Ice Dispenser

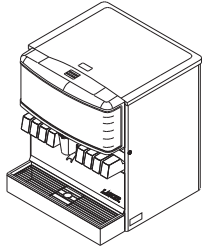

4500

22" Ice-Bev Dispenser

W: 22" D: 30 1/2" H: 35 3/8"
Shipping weight: 255 lbs
Ice capacity: 180 lbs

25" Ice-Bev Dispenser

W: 25" D: 30 1/2" H: 35 3/8"
Shipping weight: 275 lbs
Ice capacity: 210 lbs

30" Ice-Bev Dispenser

W: 30" D: 30 1/2" H: 35 3/8"
Shipping weight: 305 lbs
Ice capacity: 250 lbs

44" Ice-Bev Dispenser

W: 44" D: 30 1/2" H: 35 3/8"
Shipping weight: 460 lbs
Ice capacity: 360 lbs

Cubelet capable dispensers are
4 5/8" taller than current specs

Power supply: 115V; 75VA
Fittings: 3/8" barbed
Flex water option
Leg kit standard
Key lock standard

Tested to UL, CSA and
NSF standards by ETL

Rated at Condition "C" by
The Coca-Cola Company

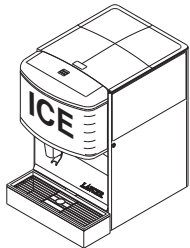

4400

22" Ice Dispenser

W: 22" D: 30 1/2" H: 35 3/8"

30" Ice Dispenser

W: 30" D: 30 1/2" H: 35 3/8"

PART NUMBER	VALVE TYPE	NUMBER OF VALVES	MANIFOLD CONFIGURATION	LIST PRICE
ICE BEVERAGE DISPENSERS				
22" ICE BEV DISPENSER				
85-4526H-101	LEV® PB	6	3-2-1	\$5,309.00
85-4526H-111	LEV® SSL	6	3-2-1	\$5,226.00
85-4526N-111	LEV® SSL	6	3-2-1	\$5,383.00

25" ICE BEV DISPENSER				
85-4528H-101	LEV® PB	8	3-1-1-3	\$6,399.00
85-4528H-111	LEV® SSL	8	3-1-1-3	\$6,288.00

30" ICE BEV DISPENSER				
85-4548H-101	LEV® PB	8	3-1-1-3	\$6,923.00
85-4548H-111	LEV® SSL	8	3-1-1-3	\$6,619.00
85-4548N-111	LEV® SSL	8	3-1-1-3	\$7,266.00
85-4541H-101	LEV® PB	10	3-1-2-1-3	\$7,988.00
85-4541N-111	LEV® SSL	10	3-1-2-1-3	\$7,620.00
85-4541H-111	LEV® SSL	10	3-1-2-1-3	\$7,846.00

44" ICE BEV DISPENSER				
85-4562H-101	LEV® PB	12	3-2-1-1-2-3	\$11,718.00
85-4562H-111	LEV® SSL	12	3-2-1-1-2-3	\$11,548.00

OPTIONS		
82-2339	22" Splash Guard Kit	\$89.64
82-2340	30" & 44" Splash Guard Kit	\$92.31

ICE DISPENSERS		
22" ICE DISPENSER		
85-4420H	Ice Dispenser	\$3,610.00
85-4420H-02	With T & S Water Valve	\$4,753.00

30" ICE DISPENSER		
85-4440H	Ice Dispenser	\$4,471.00
85-4440H-02	With T & S Water Valve	\$4,753.00

Ice Cooled Dispensers

PART NUMBER	VALVE TYPE	NUMBER OF VALVES	MANIFOLD CONFIGURATION	LIST PRICE
ICE COOLED DISPENSERS				
1523 STANDARD PERFORMANCE STAINLESS STEEL TOWER				
85-3075-111	LEV® SSL	5	2-1-2	\$3,215.00
85-3076-110	LEV® PC	6	3-2-1	\$4,039.00
85-3076-111	LEV® SSL	6	3-2-1	\$3,234.00
1523 HIGH PERFORMANCE PLUG-IN STAINLESS STEEL TOWER				
85-2186-111	LEV®	6	3-2-1	\$4,301.00
85-2186-110	LEV® PC	6	3-2-1	\$5,307.00
85-2186-120	LHF	6	3-2-1	\$4,569.00
1523 HIGH PERFORMANCE PLUG-IN SABRE TOWER				
85-3065F-111	LEV® SSL	5	3-1-1	\$4,286.00
OPTIONS				
84-0006	1523 Cabinet Stand			\$533.68
82-1580-SP	Ambient Water Spigot Kit			\$305.38
82-2479-SP	Splash Guard Kit			\$152.92
85-2304-01	Merchandiser S/S Tower Units, Coke			\$415.82
85-2301-10	Marquee S/S Towers Units, Coke			\$546.67

2200 Drop-In ICD



2200 ICD 1523 Standard Performance Soft Plumbed Stainless Steel Tower

1523 High Performance Plug-In Stainless Steel Tower

1523 High Performance Plug-In Sabre Tower

W: 15" D: 23" H: 33 3/8" Max
 Electrical: 24VAC/60Hz
 Counter cutout:
 W: 15 1/4" H: 23 1/4"
 Shipping weight: 130 lbs
 Ice capacity: 60 lbs
 Fittings: 3/8" barbed
 Flex water option
 Key lock standard

NSF Listed

Rated at Condition "C" by
 The Coca-Cola Company

Ice Cooled Dispensers

2300 Drop-In ICD

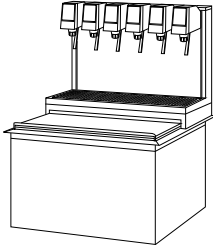

2300 ICD

**2323 Standard Performance
Soft Plumbed
Stainless Steel Tower**

**2323 High Performance
Plug-In
Stainless Steel Tower**

**2323 High Performance
Plug-In
Sabre Tower**

W: 23" D: 23" H: 36 1/4" Max
Electrical: 24VAC/60Hz
Counter cutout:
W: 23 1/4" H: 23 1/4"
Shipping weight: 130 lbs
Ice capacity: 100 lbs
Fittings: 3/8" barbed
Flex water option
Key lock standard

NSF Listed

Rated at Condition "C" by
The Coca-Cola Company

PART NUMBER	VALVE TYPE	NUMBER OF VALVES	MANIFOLD CONFIGURATION	LIST PRICE
-------------	------------	------------------	------------------------	------------

ICE COOLED DISPENSERS

2323 STANDARD PERFORMANCE STAINLESS STEEL TOWER

85-2376-110	LEV® PC	6	3-2-1	\$4,510.00
85-2376-111	LEV® SSL	6	3-2-1	\$3,687.00
85-2378-111	LEV® SSL	8	3-1-1-3	\$4,329.00

2323 HIGH PERFORMANCE PLUG-IN STAINLESS STEEL TOWER

85-2346T-110	LEV® PC	6	3-2-1	\$6,142.00
85-2346T-111	LEV® SSL	6	3-2-1	\$5,417.00
85-2346T-123	LHF SSL	6	3-2-1	\$5,559.00
85-2378T-110	LEV® PC	8	3-1-1-3	\$6,937.00
85-2378T-111	LEV® SSL	8	3-1-1-3	\$5,812.00
85-2378T-120	LHF	8	3-1-1-3	\$5,986.00
85-2378T-122-06	LHF PC	8	3-1-1-3	\$6,555.00
85-2378T-123	LHF SSL	8	3-1-1-3	\$5,997.00

2323 HIGH PERFORMANCE PLUG-IN SABRE TOWER

85-2346F-111	LEV® SSL	6	3-2-1	\$5,425.00
85-2346F-110	LEV® PC	6	3-2-1	\$6,142.00
85-2346F-123	LHF SSL	6	3-2-1	\$5,559.00

OPTIONS

84-0058	2323 Cabinet Stand	\$606.97
82-1580-SP	Ambient Water Spigot Kit	\$305.38
82-2076-SP	Splash Guard Kit	\$152.92
85-2304-01	Merchandiser S/S Tower Units, Coke	\$415.82
85-2302-10	Marquee S/S Towers Units, Coke	\$546.67

Ice Cooled Dispensers

PART NUMBER	VALVE TYPE	NUMBER OF VALVES	MANIFOLD CONFIGURATION	LIST PRICE
ICE COOLED DISPENSERS				
3023 HIGH PERFORMANCE PLUG-IN STAINLESS STEEL TOWER				
85-2348T-111	LEV® SSL	8	3-1-1-3	\$6,919.00
85-2348T-110	LEV® PC	8	3-1-1-3	\$8,050.00
85-2348T-120	LHF	8	3-1-1-3	\$7,099.00
85-2348T-122	LHF PC	8	3-1-1-3	\$8,199.00

OPTIONS

84-0059	3023 Cabinet Stand		\$894.00
82-1580-SP	Ambient Water Spigot Kit		\$305.38
82-2077-SP	Splash Guard Kit		\$182.99
85-2304-01	Merchandiser S/S Tower Units, Coke		\$415.82
85-2303-11	Marquee S/S Towers Units, 3 Cup		\$717.08

ICE CHESTS

1522 ICE CHEST

85-0408	DI1522	8	Post Mix Chest	\$1,244.14
85-0461	FS1522	8	Post Mix Chest	\$1,335.70
51-0389	Leg Set 1522			\$113.84

2123 ICE CHEST

85-0402	DI2123	9	Post Mix Chest	\$1,649.17
85-0462	FS2123	9	Post Mix Chest	\$1,430.00
51-0652/01	Leg Set 2123			\$123.56

23308 Drop-In ICD — Ice Chests

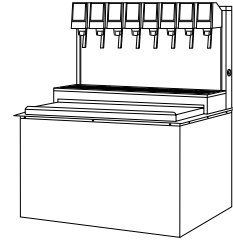

23308 ICD 3023 High Performance Plug-In Stainless Steel Tower

W: 30" D: 23" H: 35 1/2"
 Electrical: 24VAC/60Hz
 Counter cutout:
 W: 30 1/4" H: 23 1/4"
 Shipping weight: 300 lbs
 Ice capacity: 130 lbs
 Fittings: 3/8" barbed
 Flex water option
 Key lock standard

NSF Listed

Rated at Condition "C" by
 The Coca-Cola Company

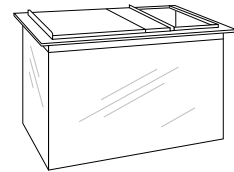

Drop-In Ice Chest
 W: 22" D: 15" H: 14 1/4"

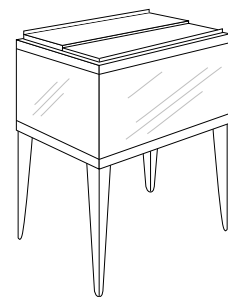

Free Standing Ice Chest
 W: 23" D: 21" H: 33 3/4"

Counter Electric Dispensers

500 CED-1500 CED

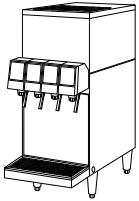

500, 1500 CED
*Specs Below

500 Juice

W: 10 3/8"

D: 25 1/4"

H: 27 1/2"

Weights:

Shipping: 108 lbs

Ice bank: 17 lbs

Leg Kit standard

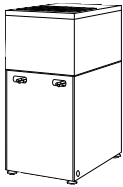

500 Pre Chiller

W: 10 3/8"

D: 19 11/16"

H: 23 1/2"

*** 500, 1500 CED SPECIFICATIONS**

Electrical: 115V/60Hz, 7A

Transformer: 24 VAC

Agitator: 15W

Condenser Fan: 9W

Fittings: 3/8" barbed

Stainless steel tank, cabinet and lines Flex water option

Refrigerant: R134A

Key lock standard

Tested to UL, CSA and NSF standards by ETL

Rated at Condition "C" by The Coca-Cola Company

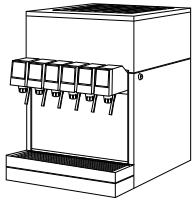

1500E Standard Performance

1500 High Performance

1500E Juice

W: 19 3/16"

D: 24"

H: 25 3/8"

Weights:

Shipping: 150 lbs

Ice Bank: 30 lbs

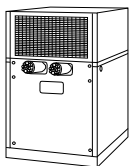

1500 Pre Chiller

W: 19 3/16"

D: 19 1/8"

H: 25 3/8"

PART NUMBER	VALVE TYPE	NUMBER OF VALVES	MANIFOLD CONFIGURATION	LIST PRICE
CED - AMBIENT CARBONATED				
500				
85-0504A-101	LEV® PB	4	2-2	\$3,171.00
85-0504A-111	LEV® SSL	4	2-2	\$3,116.00

500 BIB JUICE

85-0514A-107	FloMatic PB	4	Ambient Juice	\$3,061.00
85-0514A-108	FloMatic Lever	4	Ambient Juice	\$3,016.00

500 PRE CHILLER

85-0552A	2 circuits			\$1,891.01
----------	------------	--	--	------------

CED - AMBIENT CARBONATED

1500E STANDARD PERFORMANCE

85-1596A-101	LEV® PB	6	3-2-1	\$3,750.00
85-1596A-111	LEV® SSL	6	3-2-1	\$3,666.00

1500 HIGH PERFORMANCE

85-1506A-111	LEV® SSL	6	3-2-1	\$4,412.00
85-1506A-101	LEV® PB	6	3-2-1	\$4,496.00

1500E STANDARD PERFORMANCE BIB JUICE

85-1516A-107	FloMatic PB	6	Ambient Juice	\$3,634.00
85-1516A-108	FloMatic Lever	6	Ambient Juice	\$3,566.00

1500 PRE CHILLER

85-1554A	4 circuits			\$2,845.00
85-1556A	6 circuits			\$2,890.00

OPTIONS

82-1049	Leg Kit 1500E Post Mix and Pre-Mix	\$63.79
82-0025	Leg Kit 1500	\$50.69
82-1801	Lighted Marquee Kit - 24VAC	\$379.17

Counter Electric Dispensers

PART NUMBER	VALVE TYPE	NUMBER OF VALVES	MANIFOLD CONFIGURATION	LIST PRICE
CED - AMBIENT CARBONATED				
2500				
85-2508A-101	LEV® PB	8	3-1-1-3	\$6,702.00
85-2508A-111	LEV® SSL	8	3-1-1-3	\$6,586.00
2500 PRE CHILLER				
85-2554A	4 circuit			\$4,975.00
85-2556A	9 circuit			\$5,354.00
2500 REMOTE BEVERAGE SYSTEM				
85-2550A	9 circuit			\$8,956.00
OPTIONS				
82-0344		Leg Kit 2500		\$140.77
CED - COLD CARBONATED				
9000				
85-9946-2000	LEV®	6	3-3	\$5,001.00
85-9946S-2011M	LEV® SSL	6	3-3	\$5,252.00
8000				
85-8058-100	LEV®	8	8 or 4-8, 1-4	\$7,918.00

2500 CED

2500 High Performance Post Mix

W: 26" D: 27 1/8" H: 31 1/4"

Electrical: 115V/60Hz, 12A

Transformer: 24VAC

Agitator: 25W

Condenser fan: 35W

Weights:

Shipping: 257 lbs

Ice bank: 55 lbs

Fittings: 3/8" barbed

Flex water option

Stainless steel tank, cabinet and lines

Refrigerant: R134A

Key lock standard

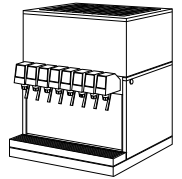

Tested to UL, CSA and NSF standards by ETL

Rated at Condition "C" by The Coca-Cola Company

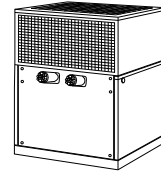

2500 Pre Chiller

W: 26" D: 27 1/8" H: 31 1/4"

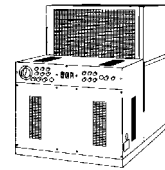

2500 Remote

W: 26" D: 37 1/4" H: 31 1/4"

Towers

Towers

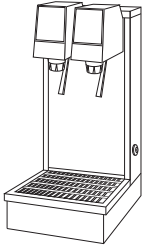

300 Island Base Dispensing Tower

2-Valve

W: 7 1/2" D: 9 1/4" H: 16 1/2"

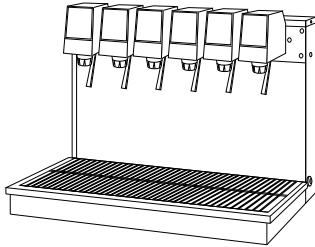

6-Valve

W: 23 1/2" D: 13 3/4" H: 16"

PART NUMBER	VALVE TYPE	NUMBER OF VALVES	MANIFOLD CONFIGURATION	LIST PRICE
-------------	------------	------------------	------------------------	------------

TOWERS

300 ISLAND BASE DISPENSING TOWER

85-3132-111	LEV®SSL	2	1-1	\$665.00
85-3132-101	LEV®PB	2	1-1	\$693.00
85-3132-110	LEV®PC	2	1-1	\$899.00
85-3136-101	LEV®PB	6	3-1-2	\$2,472.00
85-3136-110	LEV®PC	6	3-1-2	\$3,091.00
85-3136-111	LEV®SSL	6	3-1-2	\$2,388.00

Pre-Mix Dispensers

PART NUMBER	VALVE TYPE	NUMBER OF VALVES	MANIFOLD CONFIGURATION	LIST PRICE
PRE-MIX DISPENSERS				
1500 CED PRE-MIX				
85-1586A	Becker	6		\$3,274.00
OPTIONS				
82-1049		Leg Kit 1500E		\$63.79

ICD, CED, IBD Pre-Mix

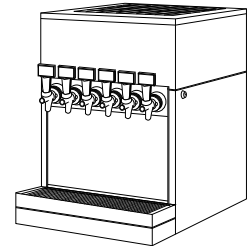

1500 CED Pre-Mix
W: 29 3/16" D: 24" H: 25 3/8"

Accessories

Carbonator, Installation Kits, Regulators, Bundle Tubing, Syrup Pump Kits

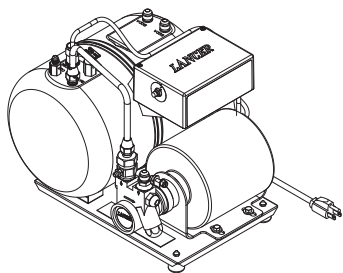

Carbonator

Power supply: 115 V; 75 VA
 Fittings: 1/4" barbed CO2
 3/8" barbed water
 NSF, UL Approved

PART NUMBER

DESCRIPTION

LIST PRICE

ACCESSORIES

CARBONATOR

85-1923-00	Turbo with Back Flow Preventor	\$647.86
------------	--------------------------------	----------

INSTALLATION KITS

82-1796	6 Product Install Kit and Regulator	\$548.00
82-2779	12 Product Install Kit and Regulator	\$601.00

REGULATORS

18-0048/01	Primary, high pressure, tank mount	\$115.77
18-0089/01	Secondary, low pressure, wall mount	\$76.92

BUNDLE TUBING

08-0404	10 line bundle Furon	priced per foot	\$11.70
* 08-0403	14 line bundle Furon	priced per foot	\$13.09
08-0472	10 line bundle Flo-Guard	priced per foot	\$8.19
** 08-0471	12 line bundle Flo-Guard	priced per foot	\$7.33
*** 08-0470	14 line bundle Flo-Guard	priced per foot	\$8.66
49-0080	10 Line Python Insulated Bundle	priced per foot	\$26.28

SYRUP PUMP KITS

FJ-5000-564	1 Install Pump, FloJet	\$137.00
86-0141-02	Coca-Cola Kit Assembly	\$150.76
86-0141-01	General Beverage Kit Assembly	\$167.64

* Minimum 100' and 100' multiples

** Minimum 150' and 150' multiples

*** Minimum 200' and 200' multiples

Accessories

PART NUMBER	CONFIGURATION	NUMBER OF FLOJET PUMPS	NUMBER OF BOXES	DIMENSIONS HxVxD	WEIGHT	LIST PRICE
ACCESSORIES						
BIB Racks						
85-1803-2306	2x3, w/ Reg	6	6 Box	33"x28"x17"	87	\$1,592.00
85-1803-2406	2x4, w/ Reg	6	8 Box	44"x28"x17"	105	\$1,533.00
85-1803-2408	2x4, w/ Reg	8	8 Box	44"x28"x17"	105	\$2,027.00
82-0660-601	2x5, w/ Reg	5	10 Box	56.5"x28"x17"	115	\$1,477.00
82-0662-601	2x5, w/ Reg	6	10 Box	56.5"x28"x17"	115	\$1,637.00
85-1803-2510	2x5, w/ Reg	10	10 Box	56.5"x28"x17"	115	\$2,431.00
85-1803-2610	2x6, w/ Reg	12	10 Box	68"x28"x17"	129	\$2,463.00
85-1803-2612	2x6, w/ Reg	12	12 Box	68"x28"x17"	129	\$2,840.00
85-1803-2614	2x6, w/ Reg	14	12 Box	68"x28"x17"	129	\$2,923.00
82-0661-601	3x5, w/ Reg	5	15 Box	56"x41"x17"	140	\$1,650.00
82-0663-601	3x5, w/ Reg	6	15 Box	56"x41"x17"	140	\$1,722.00
82-1792-601	3x5, w/ Reg	8	15 Box	56"x41"x17"	140	\$2,033.00
85-1803-3512	3x5, w/ Reg	12	15 Box	56"x41"x17"	140	\$2,664.00
85-1803-3514	3x5, w/ Reg	14	15 Box	56"x41"x17"	140	\$3,252.00
85-1803-3516	3x5, w/ Reg	16	15 Box	56"x41"x17"	140	\$3,666.00
85-1803-3518	3x5, w/ Reg	18	15 Box	56"x41"x17"	140	\$3,717.00
85-1803-3616	3x6, w/ Reg	16	18 Box	67"x41"x17"	159	\$3,758.00
85-1803-3618-SP	3x6, w/ Reg	18	18 Box	67"x41"x17"	159	\$4,453.00
85-1803-3621	3x6, w/ Reg	21	18 Box	67"x41"x17"	159	\$4,588.00

BIB Racks

BIB Rack

2 Box Wide
W: 28" D: 19" H: 11"

3 Box Wide
W: 39" D: 19" H: 11"

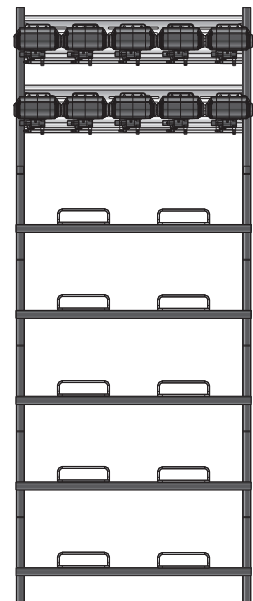
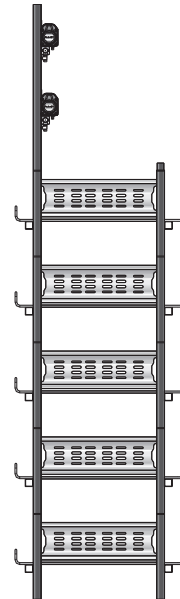

Fittings

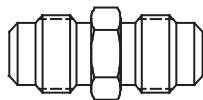
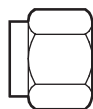
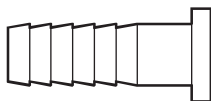
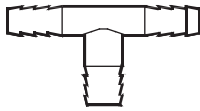
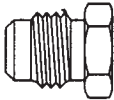
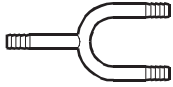

We offer a complete line of fittings to complement our products.

Please contact your Lancer sales representative, distributor or authorized service agent for pricing.

Directory of Offices and Authorized Distributors

LANCER WORLDWIDE

www.lancercorp.com

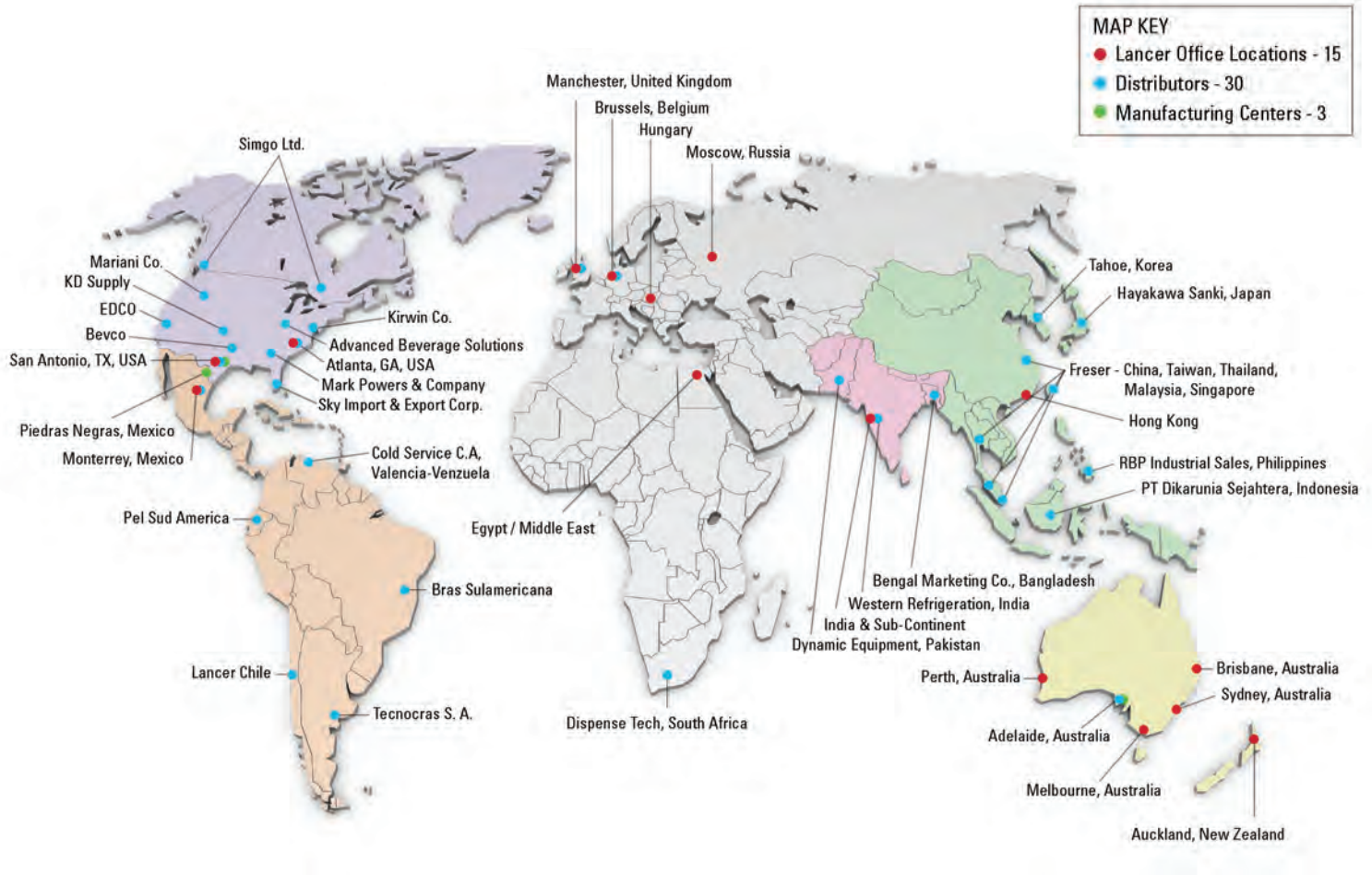

Lancer USA Manufacturing Locations

Foster Road Facilities - USA

6655 Lancer Blvd.
 San Antonio, TX 78219
 Phone: 210-310-7000
 MFG Fax: 210-310-7088
 ENG Fax: 210-310-7096
 ACCT Fax: 210-310-7091
 PURCH Fax: 210-310-7094

Manufacturing - Mexico

Industrias Lancermex S.A. de C.V.
 Victoria No. 2708 Nte Colonia Mundo Nuevo CP
 260 10, Mexico
 Phone: 011-52 (878) 782-6600
 ENG Fax: 011-52 (878) 782-5401
 ACCT Fax: 011-52 (878) 782-9240
 PURCH Fax: 011-52 (878) 782-2302

Warehouse

Eagle Pass Warehouse
 1793 Brown Street
 Building A-2
 Eagle Pass, TX 78852-5423
 Phone: 830-757-5770
 Fax: 830-757-4381

Note: Please refer to the Lancer website (www.lancercorp.com) for information relating to Lancer installation and service manuals, instruction sheets, technical bulletins, service bulletins, etc.

Directory of Offices and Authorized Distributors

LANCER NORTH AMERICA

www.lancercorp.com

MAP KEY

- Lancer Office Locations - 2
- Distributors - 8
- Manufacturing Centers - 1

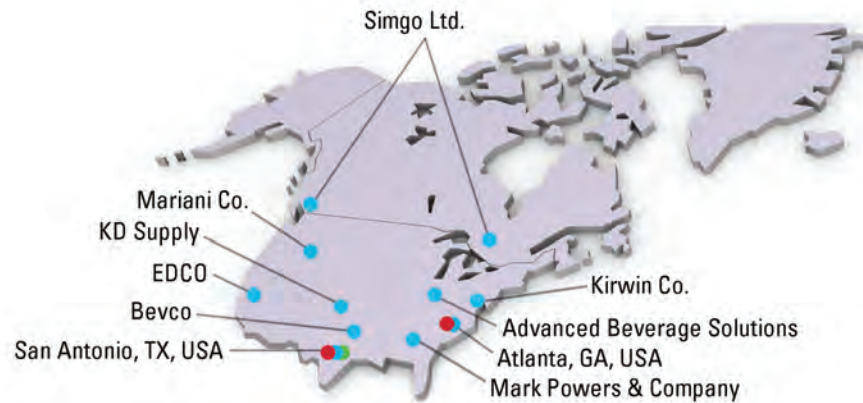

USA - Canada Sales

6655 Lancer Blvd.
San Antonio, TX 78219
Phone: 210-310-7000
Sales Fax: 210-310-7245
Customer Service Fax: 210-310-7250
1-800-729-1500

Georgia Office

645 Hembree Parkway, Suite J
Roswell, GA 30076
Phone: 770-343-8828
Fax: 770-475-8646
1-800-729-1750

Lancer Authorized Distributors

Advanced Beverage Solutions (ABS)

100 N. Gary Avenue, Suite C
Roselle, IL 60172
Phone: 847-524-1707
877-814-2271
Fax: 847-524-1710
Website: www.absonline.com

Joe Kirwan Company

119 White Oak Lane
Old Bridge, NJ 08857
Phone: 732-679-1900
Fax: 732-679-9236
E-mail: sales@jkirwan.com

Mark Powers & Company, Inc.

P.O. Box 72
1821 Henry Street
Guntersville, AL 35976
Phone: 256-582-6620
Fax: 256-582-8533
E-mail:
sales@markpowers-and-company.com

Bevco

6900 Camille Avenue
Oklahoma City, OK 73149
Phone: 405-672-7770
800-460-4238
Fax: 405-672-7443
E-mail: sales@bevcoinc.com

KD Supply

18150 East 32nd Place, Unit E.
Aurora, CO 80011
Phone: 303-577-1260
Toll Free: 800-226-7146
Fax: 303-577-0212
E-mail: sales@kdsupplyllc.com
Website: www.kdsupplyllc.com

Simgo Ltd.

5122 Timberlea Blvd.
Mississauga, Ontario L4W 2S5
Canada
Phone: 905-602-5800
Fax: 905-602-5804
E-mail: simgo@simgo.com

EDCO Distributing Inc.

3150 Scott Street
Vista, CA 92081
Phone: 760-598-3830
800-540-EDCO
Fax: 760-598-3834
Website: www.edcodistributing.com

Ernest F. Mariani Company

614 West 600 South
Salt Lake City, UT 84104
Phone: 801-359-3744
Fax: 801-531-9615
E-mail:
febell@efmco.com, or clay@efmco.com

Simgo (B.C.) Ltd.

16-8125 - 130th Street
Surrey, B.C. V3W 7X4
Canada
Phone: 604-590-4022
Fax: 604-590-1601

Note: Please refer to the Lancer website (www.lancercorp.com) for information relating to Lancer installation and service manuals, instruction sheets, technical bulletins, service bulletins, etc.



MAP KEY

- Lancer Office Locations - 1
- Distributors - 6
- Manufacturing Centers - 1

Latin America Sales

6655 Lancer Blvd.
 San Antonio, TX 78219
 Phone: 210-310-7000
 1-800-729-1500
 Fax: 210-310-7245
 E-mail: latinamerica@lancercorp.com

Lancer de Mexico, S.A. de C.V.

Contact: Carlos Robles
 Av. Balcones de Anahuac #346-A
 Parque Industrial Stiva Barragan
 San Nicolas De Los Garza, N.L.
 Mexico C.P. 66425
 Phone: (52)-81-88-50-60-00
 Fax: (52)-81-88-50-60-09
 E-mail: Carlos.robles@lancer.com.mx

Lancer Authorized Distributors

PEL SudAmerica - Ecuador

Lancer Sales Company
 Contact: Luciano Lopez
 Alonso de Torres #278 y Beck Rollo
 Edificio Monte Doral
 Piso 12 - Dpto. 124
 Quito, Ecuador
 Phone: (5932) 2400937
 Fax: (5932) 24060661
 E-mail:
 pelsudamerica.llopez@uio.satnet.net

Bras Sulamericana LTDA. - Brasil

Contact: Fabio Queiroz
 Rua. Dr. Ladislau Retti, 1400
 Parque Alexandre
 Cotia Sao Paulo - Brasil
 CEP: 06714-150
 Phone: 55-11-4612-1122
 Fax: 55-11-4612-2219
 E-mail: fabio.queiroz@bras.com.br

Lancer Chile Ltda. - Chile

Contact: Heriberto Concha
 Vicuna mackenna 3019, San joaquin
 Santiago, Chile
 Phone: 56-2-5521657
 Fax: 56-2-5521961
 E-mail: lancorchile@lancer.tie.cl

Tecnocras S.A. - Argentina

Contact: Cecilia Mendoza
 Av. del Libertador 774 - Piso 9 Depto Y
 (1000) Buenos Aires
 Argentina
 Phone: (54.11)4815.3448
 Fax: (54.11)4815.3449
 E-mail: adm@tecnocras.com

Sky Import & Export Corp.

(See page 14 for location on map)
 Contact: Cecilia Mendoza
 1375 N.W. 97 Ave. Unit #9
 Doral, FL 33172
 Phone: 305-716-9072
 Fax: 305-716-9082

Cold Service C.A.

Contact: Bill Craig
 Av. Henry Ford Zona Ind. Sur
 Fte. A Rualca, Valencia-Venezuela
 Phone: 58-241-913-0572
 Fax: 58-241-833-2026

Directory of Offices and Authorized Distributors

LANCER EUROPE

www.lancereurope.be

MAP KEY

- Lancer Office Locations - 5
- Distributors - 3



Belgium - European Central Office

Lancer Europe, S.A.
 Mechelsesteenweg 592
 B-1930 Zaventem
 Belgium
 Phone: 32-2-755-2390
 Fax: 32-2-755-2399
 E-mail: info@lancereurope.be

England

Managing Director
 Contact: Paul Haskayne
 Lancer G.B. Llp.
 Unit 9 Prosperity Court, Midpoint 18
 Middlewich CW10 0GD
 Cheshire, United Kingdom.
 Phone: 441606837711
 Fax: +441606832705
 E-mail: phaskayne@lancergb.co.uk

Hungary

H-2100 Gödöllő
 Isaszegi út 67
 Hungary
 Phone: 36-28-417-179
 FAX: 36-28416-881
 e-mail: bodolai@compuserve.com

Lancer International Sales, Inc.

Representation Office
 Kashirskoe shosse, 65 (1), Office 610
 Moscow 115583 Russia
 Mail: Moscow, 115551, Mail Box #2, Russia
 Phone: 7-495-727-4063
 Fax: 7-495-727-4064
 Mobile Phone: 7-495-991-7778
 E-mail: Vladimir.Demkin@orinet.ru
 lancer@online.ru

Egypt / Middle East

Elsayed Moniem - Regional Manager
 Lancer Middle East/Africa
 7 Mubarak Street
 East Ain Shams 11311
 Cairo, Egypt
 Phone: 2-02-49-35-395
 Fax: 2-02-49-33-914
 Mobile Phone (GSM): 2-010-500-4007
 E-mail: elsayed_lancer@msn.com

Lancer Authorized Distributors

DispenseTech - South Africa

P.O. Box 17495
 Sunward Park, 1470
 South Africa
 Phone: 27-11-397-7455
 Fax: 27-11-397-7648
 E-mail: david@dispensetech.co.za

Note: Please refer to the Lancer website (www.lancercorp.com) for information relating to Lancer installation and service manuals, instruction sheets, technical bulletins, service bulletins, etc.

MAP KEY

- Lancer Office Locations - 1
- Distributors - 9



International Sales

6655 Lancer Blvd.
San Antonio, TX 78219
Phone: 210-310-7000
Fax: 210-310-7242
1-800-729-1500
E-mail: asia@lancercorp.com

Hong Kong

Patrick Co - Director Asia
Flat A, 24/F., Houston Industrial Bldg.
32-40 Wang Lung Street
Tsuen Wan, N. T., Hong Kong
Phone: 852-94302585
Fax: 852-24082605
E-mail: patrickco@lancer-asia.com

Lancer Authorized Distributors

Indonesia

P.T. Dikarunia Sejahtera - Indonesia
Jl. Gelong Baru Tengah #1A
Tomang, Jakarta, Barat 11440
Indonesia
Phone: 62-21-5694-3245
Fax: 62-21-560-6889
E-mail: dikarunia@cbn.net.id

Philippines

RBP Industrial Sales, Inc. - Philippines
Unit 20, 2/F, Facilities Centre Bldg.
548 Shaw Blvd
1552 Mandaluyong City
Philippines
Phone: 632-531-1221/1215/1289
Fax: 632-531-1271
E-mail: rbpsales@pltdsl.net
rbp@pltdsl.net

Shanghai Freser International Co Ltd. - China

No.868 Kangqiao Rd. Kangqiao
Industrial Area, Pudong
Shanghai 201315, China
Phone: (021) 3135-9666
Fax: 86-21-3135-9555
E-mail: daniel.xie@freser.com.cn

Freser (HK) Company Ltd - Hong Kong

Flat A, 24/F., Houston Industrial Bldg.
32-40 Wang Lung Street
Tsuen Wan, N. T., Hong Kong
Phone: 852-2408-2595
Fax: 852-2408-2605
E-mail: freserhk@netvigator.com

Freser (MALAYSIA) SDN. BHD. - Malaysia

No. 31, Jalan TPP 5/13, Taman
Perindustrian Puchong, Seksyen 5,
47100 Puchong, Selangor, Malaysia
Phone: 60-3-8061-6666
Fax: 60-3-8062-1007
E-mail: freser@tm.net.my

Freser (S) Pte Ltd - Singapore

621 Aljunied Road
#02-09 Lipo Building
Singapore 389834
Phone: 65-6746-8191
Fax: 65-6746-8196
E-mail: fresersin@pacific.net.sg

Freser International Corporation - Taiwan

No. 76, Gui-Sui Street
Taipei 103, Taiwan R.O.C.
Phone: 886-2-2553-1555
Fax: 886-2-2553-2742
E-mail: herman.wang@freser.com.tw

Freser (Thailand) Co., Ltd. - Thailand

Freser Makasan International Co., LTD.
Navanakorn Industrial Estate Zone 4
95/3 Moo 13, Klongnung, Klongluang
Patumthani 12120, Thailand
Phone: 662 520-3457 (Automatic, 7 lines)
Fax: 662 529-3840
E-mail: sirinuch@freser-thailand.com

Hayakawa Sanki - Japan

Hayakawa Sanki, Inc.
1-13-13, Kayaba-cho
Nihonbashi, Chuo-ku
Tokyo, 103-0025
Japan
Phone: 03-5651-1481
Fax: 03-5651-1445
E-mail: toshi@hayakawa-sanki.co.jp

Tahoe Corporation - Korea

Tahoe Corporation
2FL, 835-66 Yocksam-dong
Kangnam-Ku
Seoul, Korea
Phone: 82-2-557-5612, -5614
Fax: 82-2-557-5615
E-mail: tahoe@empal.com

Directory of Offices and Authorized Distributors

LANCER - INDIAN SUB-CONTINENT

www.lancercorp.com

MAP KEY

- Lancer Office Locations - 1
- Distributors - 3

India

Shabbir Shafiqi - Area Manager
India and Sub-Continent
B-7, Pannalal Silk Mill Compounds
78, LBS Marg, Bhandup (W)
Mumbai 400-078, India
Phone: 91-22-67161200
E-mail: shafiquis@vsnl.com

Lancer Authorized Distributors

Western Refrigeration Ltd - India

B-7, Pannalal Silk Mill Compounds
78 L.B.S. Marg, Bhandup (W)
Mumbai 400-078, India
Phone: 91-22-67161200
91-22-67161201
Fax: 91-22-25962257
E-mail: parmeet@westernequipments.com

Bengal Marketing Company - Bangladesh

Skylark Point (6th Floor)
Room #G-2
24/A Bijoy Nagar,
Dhaka-1000, Bangladesh
Phone: 880-2-934-2987
Fax: 880-2-935-0127
E-mail: bmc@dhaka.agni.com

Dynamic Equipment - Pakistan

Dynamic Equipment and Controls (Pvt.)
Ltd.
F-1/23, Canal Cottages, Block-D.
New Muslim Town.
Lahore. Pakistan.
Phone: 0092-42-583-6737
0092-42-583-6787
Fax: 0092-42-586-7924
E-mail: info@dynamic-eqpt.com.pk
m.ateeq@dynamic-eqpt.com.pk



Note: Please refer to the Lancer website (www.lancercorp.com) for information relating to Lancer installation and service manuals, instruction sheets, technical bulletins, service bulletins, etc.

MAP KEY

- Lancer Office Locations - 5
- Distributors - 1
- Manufacturing Centers - 1



Australia

Hoshizaki Lancer Pacific Pty Ltd
5 Toogood Avenue
Beverley 5009
PO Box 331
Welland 5007
South Australia
Phone: 61-8-8268-1388
Fax: 61-8-8268-1978
E-mail:

jthorp@hoshi.com.au
(Managing Director, Hoshi Lancer Pacific)
ssotiriou@hoshi.com.au
(for Fountain/soft drink)
bcadd@hoshi.com.au
(for Draught Products)

South Australia/Northern Territory

E-mail: chinter@hoshi.com.au

New South Wales / ACT

Hoshizaki Lancer Pacific Pty Ltd
Unit 8, 2 Holker Street
Newington 2127
New South Wales
Australia
Phone: 61-2-9648-6840
Fax: 61-2-9648-6850
E-mail: dcastle@hoshi.com.au

Victoria / Tasmania

Hoshizaki Lancer Pacific Pty Ltd
55 Keele Street
Collingwood 3066
Victoria
Australia
Phone: 61-3-8415-1920
Fax: 61-3-8415-1929
E-mail: sdevlyn@hoshi.com.au

Queensland / Northern Territory

Hoshizaki Lancer Pacific Pty Ltd
Unit 27, 256-258 Musgrave Road
Coopers Plains 4108
Queensland
Australia
Phone: 61-7-3274-5700
Fax: 61-7-3875-1805
E-mail: bthomson@hoshi.com.au

Western Australia

Hoshizaki Lancer Pacific Pty Ltd
24 Ernest Clark Road
Canning Vale 6155
Western Australia
Phone: 61-8-9455-2722
Fax: 61-8-9455-2455
E-mail:
rsmith@hoshi.com.au

New Zealand

Hoshizaki Lancer Pacific Ltd
9 O'Rorke Street
Onehunga, Auckland
PO Box 12-523
Penrose, Auckland
New Zealand
Phone: 64-9-634-3612
Mobile Phone: 64-21-745-389
Fax: 64-9-634-1472
E-mail: mpeffers@hoshi.com.au
mhooper@hoshi.com.au



LANCER[®]



CORPORATE OFFICE

6655 Lancer Boulevard
San Antonio, Texas 78219
210-310-7000
Fax 210-310-7250
www.lancercorp.com

© 2010 by Lancer Corp., all rights reserved. Coca-Cola and Bevariety are all registered trademarks of The Coca-Cola Company.

Prices and specifications are subject to change without notice.

